

bassFREQ

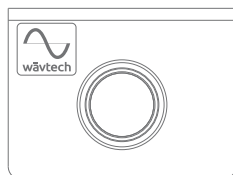
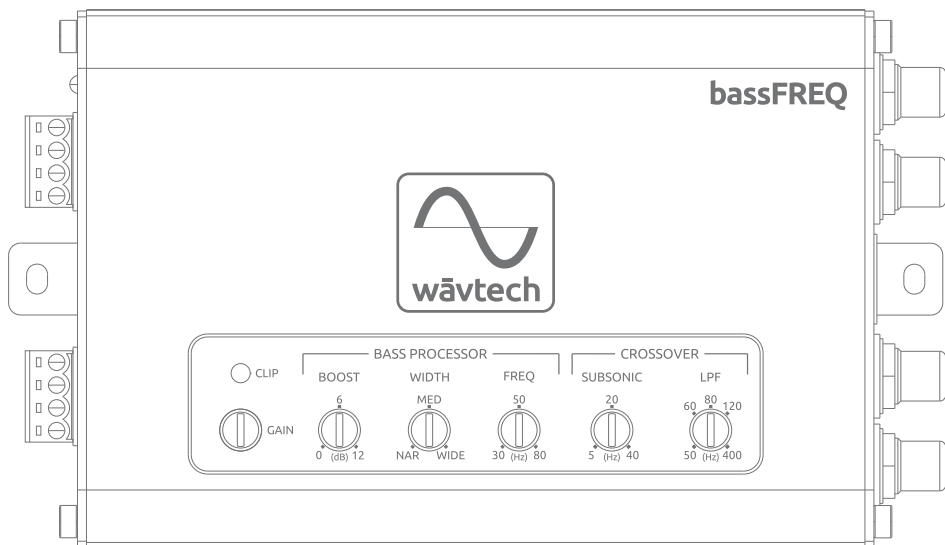

Bass Processor / LOC / Line Driver

Parametric EQ • 24dB/Oct Crossover • Remote Level Control

Owner's Manual



www.wavtech-usa.com

 WARNING	This symbol means important instructions. Failure to heed them can result in serious injury or death.
 CAUTION	This symbol means important instructions. Failure to heed them can result in injury or property damages.

WARNING

- **DO NOT DRIVE WHILE DISTRACTED.** Any function that requires your prolonged attention should not be performed while driving. Always stop the vehicle in a safe location before performing any such function. Failure to do so may result in an accident.
- **KEEP THE VOLUME AT MODERATE LEVELS WHILE DRIVING.** Excess volume levels can obscure sounds such as emergency vehicle sirens or road warning signals and may result in an accident. Continuous exposure to high sound pressure levels may cause permanent hearing loss. Use common sense and practice safe sound.
- **FOR USE WITH 12V NEGATIVE GROUND VEHICLE APPLICATIONS ONLY.** Using this product other than in its designed application may result in fire, injury or product damage.
- **MAKE THE CORRECT WIRING CONNECTIONS AND USE PROPER FUSE PROTECTION.** Failure to connect wiring correctly or use appropriate fuse protection may result in fire, injury or product damage. Ensure proper fusing of all system power wiring and install a 1-ampere in-line fuse (not included) with the +12V lead to the unit's power supply connector.
- **DISCONNECT THE NEGATIVE BATTERY TERMINAL BEFORE INSTALLATION.** Failure to do so may result in fire, injury or damage to the unit.
- **DO NOT ALLOW CABLES TO BECOME ENTANGLED IN SURROUNDING OBJECTS.** Arrange wiring and cables to prevent obstructions when driving. Cables or wiring that obstruct or hang up on places such as steering wheel, brake pedals, etc. can be extremely hazardous.
- **DO NOT DAMAGE VEHICLE SYSTEMS OR WIRING WHEN DRILLING HOLES.** When drilling holes in the chassis for installation, take precautions so as not to contact, puncture or obstruct brake lines, fuel lines, fuel tanks, electrical wiring, etc. Failure to take such precautions may result in fire or an accident.
- **DO NOT UTILIZE OR CONNECT TO ANY PART OF VEHICLE SAFETY SYSTEMS.** Bolts, nuts or wires used in the brake, airbag, steering or any other safety-related systems or fuel tanks should NEVER be used for mounting, power or ground connections. Using such parts may disable control of the vehicle or result in fire.

CAUTION

- **STOP USE IMMEDIATELY IF A PROBLEM OCCURS.** Failure to do so may result in personal injury or damage to the product. Return it to your authorized Wävtech dealer.
- **HAVE AN EXPERT DO THE WIRING AND INSTALLATION.** This unit requires special technical skill and experience for wiring and installation. To insure safety and proper function, always contact the authorized dealer where you purchased the product to have it done professionally.
- **INSTALL THE UNIT SECURELY WITH SPECIFIED PARTS.** Be sure to use only the included parts and specified installation accessories (not included). Use of other than designated parts may damage this unit. Install the unit securely so that it will not come loose during a collision or sudden jolt.
- **ROUTE WIRING AWAY FROM SHARP EDGES AND MOVING PARTS.** Arrange cables and wiring away from sharp or pointed edges and avoid moving parts such as seat hinges or rails to prevent pinching or wear. Use loom protection where appropriate and always use a grommet for any wiring routed through metal.
- **NEVER RUN SYSTEM WIRING OUTSIDE OR UNDERNEATH THE VEHICLE.** All wiring must be routed, secured and protected inside the vehicle. Failure to do so may result in fire, injury or property damage.
- **INSTALL THE UNIT IN A DRY AND VENTILATED LOCATION.** Avoid mounting locations where the unit will likely be exposed to high moisture or heat without adequate ventilation. Moisture penetration or heat buildup may result in product failure.
- **REDUCE GAIN AND SOURCE VOLUME TO MINIMUM LEVELS FOR INITIAL SYSTEM TUNING AND BEFORE CONNECTION TO AN AMPLIFIER.** Ensure amplifier power is off before connecting RCA cables and follow proper system gain setting procedure. Failure to do so may result in damage to the amplifier and/or connected components.

Package Contents:

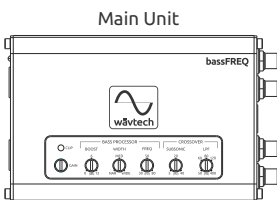

Terminals
(2pcs, detachable)



Mounting Tabs
(2pcs, detachable)



Remote Level Control



Remote Cable
(16.4ft / 5m)



Accessories Required for Installation (not included):

- RCA Interconnects
- 18AWG Wire
- In-line Fuse Holder w/1A fuse
- Battery Ring Terminal
- Ground Terminal
- Wire Crimp Connectors
- Grommets and Loom
- Cable Ties
- Mounting Screws

Introduction

Welcome to Wåvtech, exceptional mobile audio integration products for audiophiles. Our products are engineered to provide a truly remarkable listening experience. Built for the professional installer, our OEM integration and signal processor models are simply the best solution available for unlimited sound system upgrades while retaining the factory receiver.

Features

- Bass Enhancement Processor
 - Fully Adjustable Parametric EQ
 - Variable Subsonic Filter (-24dB/Oct.)
 - Variable Low Pass Filter (-24dB/Oct.)
 - Variable Gain with Clip LED
 - Remote Level Control
- Line Output Converter or Line Driver
- Differential Balanced Inputs
- Low Impedance Dual Mono Drive Outputs
- Auto Turn-On via DC-Offset or Audio Signal Detect
- Generated +12V Remote Output
- OEM Load Detect Compatible
- Selectable Ground Isolation
- Professional Grade Panel Mount RCA Output Jacks
- Detachable Power and Speaker Input Terminals
- Aluminum Chassis w/Detachable Mounting Tabs

Connections & Functions

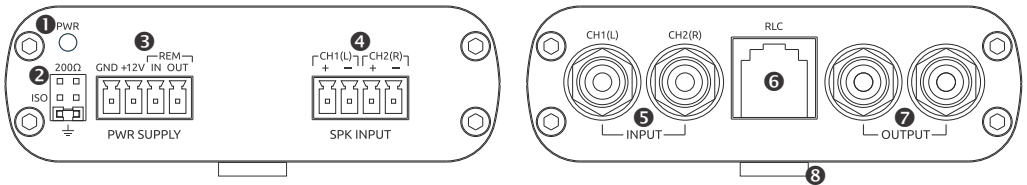

- 1 Power Indicator:** This red LED indicates when the bassFREQ is powered on. Once illuminated, there will be a short delay before audio signal output is enabled. During initial power connections, it may illuminate for a brief period.
- 2 Ground Jumper:** For selecting between chassis, isolation or 200Ω for the internal audio signal ground. Chassis ground is the default setting and ideal for most applications due to the differential input stage. In the rare case there is system noise present after all other installation countermeasures, changing this jumper to ISO or 200Ω may reduce or eliminate the noise.
- 3 Power Supply Terminal:** For +12V battery, chassis ground, remote input and remote output wire connections. A minimum of 18AWG wire is recommended for power and ground connections. Always protect the +12V power wire with a 1-amp fuse.
- 4 Speaker Level Input Terminal:** For left and right channel speaker level (a.k.a. high level) connections to the source. Input signals ranging from 2Vrms to 20Vrms will produce up to 10Vrms RCA output at maximum to minimum gain setting. Dynamic music signal peaks are allowable up to 40Vrms, but will be clipped. Use this input if your source unit does not have RCA outputs.
- 5 RCA Input Jacks:** For left and right channel low level (a.k.a. line level) signal connections to the source unit. These two channels are summed and processed internally in mono. Input signals ranging from 0.5Vrms to 5Vrms will produce up to 10Vrms RCA output at maximum to minimum gain setting.
- 6 Remote Level Control Jack:** This RJ45 jack is for connecting the supplied cable to the external level control unit for remote mounting. A standard ethernet cable may also be used.
- 7 RCA Output Jacks:** These mono line level outputs are for signal connection to your amplifier(s). Each output is an independent internal circuit, both capable of driving multiple amplifiers simultaneously. Use quality interconnects to ensure stable connection and minimize the possibility for induced noise.
- 8 Mounting Tabs:** These mounting tabs are pre-attached and should be used to properly secure the bassFREQ during installation with screws or cable ties. They are removable if the unit can be safely secured by another method.

Installation & System Wiring

It is important to read this manual thoroughly before starting your installation and always plan accordingly. Before installing any Wävtech product, disconnect the negative (ground) wire from the vehicle's battery to avoid damage to the vehicle or yourself. Following all guidelines will help provide years of enjoyment with your Wävtech bassFREQ audio interface.

Ground Connection (GND): The GND terminal must be connected to a metal part of the vehicle that is welded to the vehicle body with ground plane back to the main battery ground attachment point (a.k.a. chassis ground). This wire should be a minimum of 18AWG and as short as possible to minimize potential for noise to enter the system. The chassis ground connection point should have all of the paint removed and be scuffed to the bare metal. The ground wire should be terminated by a ground specific interlocking terminal such as the EARL terminal or ring terminal securely bolted to the vehicle with star or lock washer and nut to prevent from coming loose. Avoid using factory ground points to reduce the chance of induced noise from other components.

Power Connection (+12V): The constant power connection should be made at the vehicle battery when possible. For direct battery connection, a 1-amp fuse must be installed in-line with the power wire within 18" of the battery and securely connected to the positive battery terminal bolt with a ring terminal. If connecting to another available constant +12V power source, a 1-amp in-line fuse must be added at the connection point. The power wire should be a minimum of 18AWG. Do not install the fuse until all other system connections have been made.

Speaker Level Input (SPK): Connect the speaker wires from the source unit to corresponding terminals on the interface. Use the SPK input if your source unit is not equipped with RCA outputs. Always ensure the correct polarity of each channel when making these connections, as failure to do so can severely effect sound performance.

Remote Input (REM IN): If the source unit has a remote output wire (provides +12V only when turned on), connect it to the REM IN terminal. If a remote lead is unavailable, all Wävtech interfaces are also enabled with an automatic turn-on circuit that detects audio signal via RCA or SPK inputs, and DC-offset from SPK inputs. While auto turn-on will work in most applications, there may be some cases where detection level is not satisfactory and +12V trigger to REM IN may be required.

Remote Output (REM OUT): Use the remote output to provide a +12V trigger to turn on amplifiers or other components. This +12V output is generated internally by the interface when turned on either by REM IN or automatic sensing, and will provide over 500mA of constant current for external devices.

System Examples

Example-1: Speaker Level Input from OEM Radio

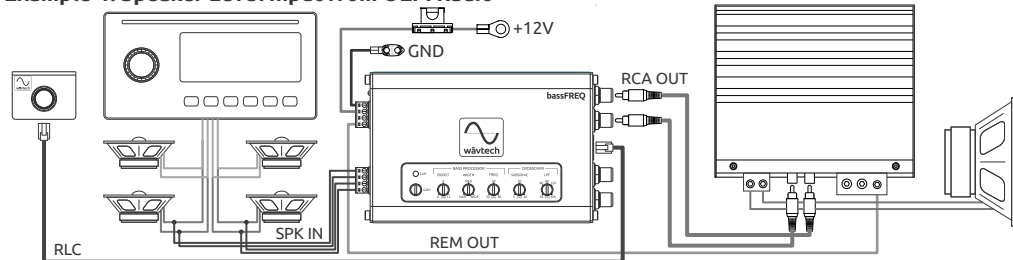

Note: When using a receiver's internal power IC to drive speakers directly, note that its speaker outputs will likely clip below the maximum master volume level. Adjust gain settings accordingly for optimum unclipped volume range.

Example-2: Speaker Level Input from OEM Amplifier

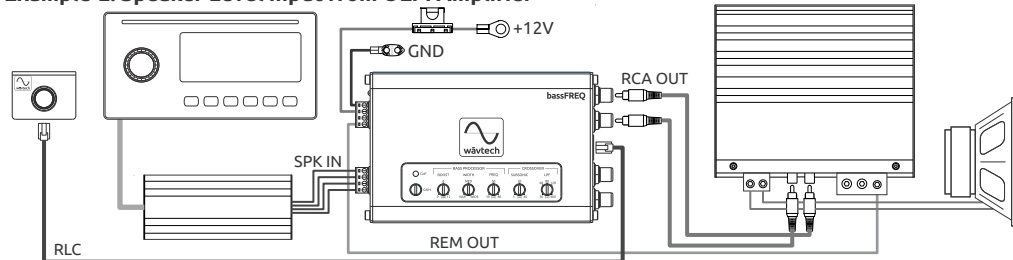

Note: In vehicles where the factory radio has a fixed level or digital output to a factory amplifier, signal for the bassFREQ's speaker level input should be connected at the amplifier's output.

Example-3: RCA Input from Aftermarket Radio

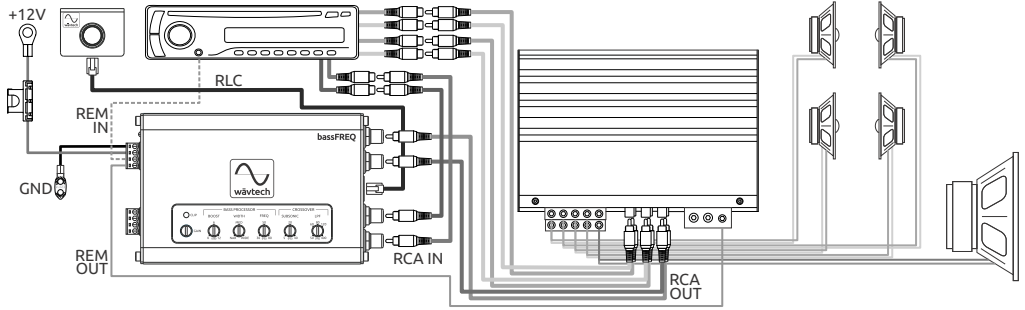

Note: Other devices such as smartphones or MP3 players may also be used as the main system source via the RCA input, which typically produce 1Vrms output or less. While the bassFREQ's auto turn-on circuit will detect very low signal levels, it may be necessary in some cases to adjust gain for reasonable listening levels but with reduced master volume range.

Top Panel Adjustments

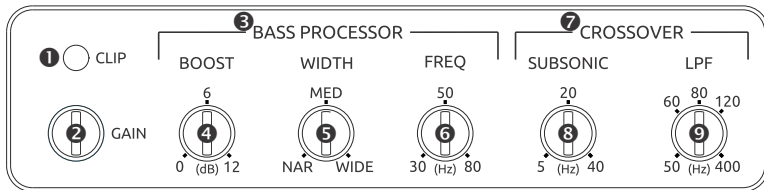

- Clipping Indicator:** This yellow LED indicates when the output signal is at maximum level before distortion (clipping) occurs. It will be dimly lit at onset of clipping, and full bright under hard clipping. If the connected amplifier(s) input can handle full 10Vrms output from the bassFREQ, then the gain is set correctly when source unit is at its maximum unclipped volume and this LED is just starting to flicker. It is likely, however, that gain will need to be reduced to match your amplifier(s) maximum input capability or optimize source volume range and desired output vs main full-range speakers.
- Gain Adjustment:** Gain adjustment is for matching the output signal level of the bassFREQ with the maximum unclipped signal range provided by your source and the maximum input capability of your amplifier(s). Follow proper gain setting procedures to ensure optimum source volume range with minimum chance for clipping at any point in the signal chain. Gain will likely need to be adjusted again after all equalization and crossovers have been set. Aside from music, a 50Hz -10dBfs signal tone or frequency sweep may be used between the chosen crossover points during the tuning process to ensure proper headroom and gain overlap for typical music recording levels.
- Bass Processor:** This parametric EQ section provides full adjustment of all parameters of a single EQ band, including boost, width and frequency. Unlike traditional bass boost, a parametric EQ provides the tuning flexibility required for differences between vehicles, subwoofers and enclosures.
 - Boost:** Provides adjustment for the amount of boost at the center frequency (F_c) set for the parametric EQ band, up to +12dB. If gain has already been adjusted, adding boost may cause the output to clip and require reduction of gain to achieve final desired unclipped output level.
 - Width:** Also known as Q, this adjustment sets the bandwidth (BW) of the parametric EQ band. A wide setting will include more adjacent frequencies for a broad boost, while a narrow setting will only boost frequencies close to the chosen center frequency (F_c). The range of Q adjustment is 1.5 (wide) to 5 (narrow). To calculate the range of frequencies boosted between the -3dB points of the EQ band, use the formula $BW = F_c/Q$.
 ⇨ Example: If frequency is set at $F_c = 50\text{Hz}$, and width is set at narrow ($Q=5$), then the boosted bandwidth will be $50\text{Hz}/5 = 10\text{Hz}$, meaning -3dB at 45Hz and 55Hz.
 - Frequency:** This adjustment is for setting the center frequency (F_c) of the parametric EQ band, between 30Hz and 80Hz.

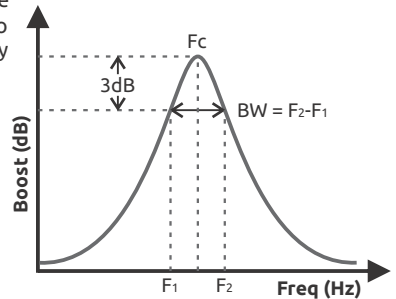

- ⑦ **Crossover:** This section is for selecting the cut-off frequencies for the low-pass filter (LPF) and subsonic filter (a.k.a. infrasonic or high-pass).
- ⑧ **Subsonic:** Provides adjustment of the lower cut-off point, below which all frequencies are filtered out at -24dB/Oct. Very low frequencies can waste amplifier power and damage subwoofers. This adjustment is especially important for ported enclosures to prevent over-exursion below the tuning frequency.
- ⑨ **LPF:** This low-pass filter adjustment sets the upper cut-off point, above which all frequencies are filtered out at -24dB/Oct. Unwanted high frequencies allowed to come through subwoofers can cause boomy, buzzy bass that is easy to localize. With a steep -24dB per octave slope, the cut-off frequency can be set higher, allowing more punch with less distortion and optimum integration with main full-range speakers for up-front bass.

Notes:

- The subsonic and low-pass filter stages are at the end of the internal circuit signal chain so that any overlapping frequencies from the parametric EQ will still be filtered at the set crossover points.
- Setting the subsonic and low-pass filter cut-off points too close together will allow only a very narrow frequency range to pass and will result in reduced output.

Specifications

Frequency response	Max Flat (+0/-1dB)		10Hz - 250Hz
	Extended (+0/-3dB)		5Hz - 400Hz
Input Impedance	Spk Input		180Ω
	RCA Input		20kΩ
Input Sensitivity	Spk Input (max-min gain)		2 - 20Vrms
	RCA Input (max-min gain)		0.5 - 5Vrms
Max Input Voltage (peak)	Spk Input	<5sec	40Vrms
	RCA Input	<60sec	15Vrms
Output Impedance			<50Ω
Max Output Voltage	at 1% THD+N		>10Vrms
THD+N	Spk Input at 10V output		<0.1%
	RCA Input at 10V output		<0.1%
S/N (signal-to-noise)	Spk Input	at 1V output	>99dBA
		at 4V output	>110dBA
		at 10V output	>118dBA
	RCA Input	at 1V output	>110dBA
		at 4V output	>120dBA
		at 10V output	>128dBA
Parametric EQ	Boost		0dB to +12dB
	Width (Q)		1.5 to 5
	Frequency (Fc)		30Hz - 80Hz
Low-Pass Filter	Frequency (F3)		50Hz - 400Hz
	Slope		-24dB/Oct.
Subsonic Filter	Frequency (F3)		5Hz - 40Hz
	Slope		-24dB/Oct.
Turn-On Trigger	Remote	via REM IN	>10.5V
	DC-offset	via Spk Input	>1.3V
	Audio Signal	via Spk Input	<100mV
		via RCA input	<10mV
		Turn-off Delay	up to 60sec
Remote Output	Current Capacity		>500mA
	Voltage		Within 3% of B+
Current Draw	Max Draw (w/o REM OUT)		<300mA
	Sleep Current		<2.5mA
Operating Voltage (B+)	Power On		10.5V-18V
	Power Off		<8.5V
Product Dimensions	Chassis (not incl. terminals)		1.1"x3.5"x5.2"
			29x90x133mm

Note: Specifications are subject to change without notice.

Installation Notes

Vehicle Description

- Year, Make, Model: _____
- Trim Level / Package: _____

OEM Audio System Info

- Head Unit (type, BT/AUX in, etc.): _____
- Speakers (size/location, etc.): _____
- Subwoofer(s) (size/location, etc.): _____
- Amplifier(s) (location, output voltage, etc.): _____
- Other: _____

bassFREQ Connections & Settings

- Installed Location: _____
- Wiring (connection locations, signal type, turn-on mode, etc): _____
- Settings (gain, max master vol, crossover, etc.): _____
- Other: _____

System Configuration: _____

Warranty & Service Care

Wävtech warrants this product to be free from defects in material and workmanship for a period of one (1) year when purchased from an authorized Wävtech retailer within the United States. This warranty will be extended to a period of two (2) years when the installation is performed by an authorized Wävtech retailer. A valid sales receipt is required to verify eligibility of purchase and installation.

This warranty is valid only to the original purchaser and is not transferrable to subsequent parties. This warranty is void if the product serial number has been altered or removed. Any applicable implied warranties are limited in duration to a period of express warranty as provided herein beginning with the date of the original purchase at retail, and no warranties, whether expressed or implied, shall apply to this product thereafter. Some states do not allow limitations on implied warranties, therefore these exclusions may not apply to you. This warranty gives you specific legal rights. You may also have other rights which vary from state to state.

If your product needs service, you should contact Wävtech Customer Service to receive a Return Authorization (RA) Number. Any product received without an RA number will be returned to sender. Once your product is received and inspected by customer service, Wävtech at its sole discretion, will repair or replace it with a new or remanufactured product at no charge. Damage caused by the following is not covered under warranty: accident, abuse, failure to follow instructions, misuse, modification, neglect, unauthorized repair or water damage. This warranty does not cover incidental or consequential damages. This warranty does not cover the cost of removing or reinstalling the product. Cosmetic damage and normal wear are not covered under warranty.

For Service within the United States:

Wävtech Customer Service: (480) 454-7017
Monday – Friday, 8:30am to 5:00pm MST

Serial Number: _____
Installation Date: _____
Place of Purchase: _____

Important Notice for International Customers:

For products purchased outside the United States of America or its Territories, please contact your local distributor concerning specific procedures for your country's warranty policy. International purchases are not covered by Wävtech, LLC.

Wāvtech™

7931 E. Pecos Rd
Suite 113
Mesa, AZ 85212
(480) 454-7017

©Copyright 2017 Wāvtech, LLC. All Rights Reserved.